



micno 深圳市迈凯诺电气股份有限公司
SHENZHEN MICNO ELECTRIC CO., LTD.

 www.micno.com.cn

 overseas@micno.com.cn

 4th Floor, Building 1, Invengo RFID Industrial Park, Tongguan Road,
Jiazitang, Guangming District, Shenzhen, China



Scan for more

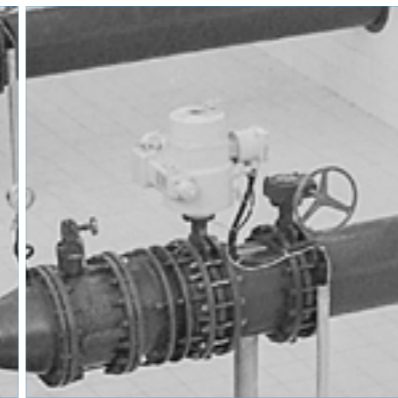
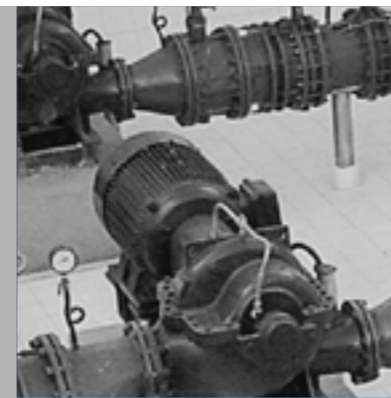

KE300A-04
SINGLE PHASE
OUTPUT
INVERTER

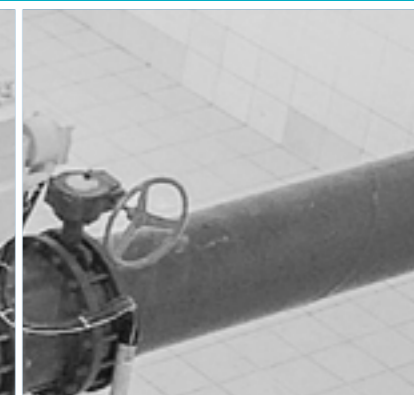
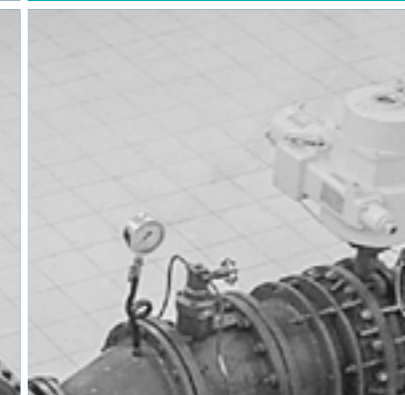
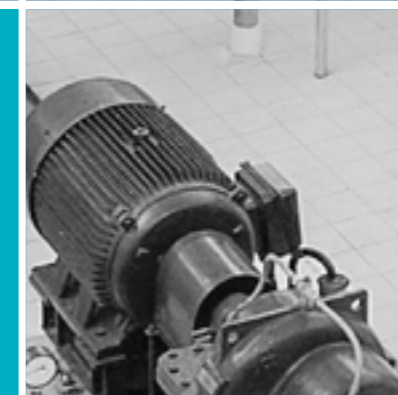

About MICNO

Shenzhen MICNO Electric Co., Ltd. is a national high-tech enterprise, which specializes in R&D, manufacture, sale and service of electrical drive, industrial automation products. MICNO headquarters is located in Guangming District Shenzhen city, has modern office and professional factory. MICNO has been a public company of NEEQ in China in 2016, with stock code 839477.

MICNO masters the leading synchronization, asynchronization current vector control technology, torque control technology and solar pump driving technology, including the main products such as general purpose inverter, various kinds of inverters of special industries and solar pump inverter. The products cover 220V, 380V, 460V, 525V, 660V voltage level with 0.4kW --1.6MW power range, which are widely used in electric power, metallurgy, petroleum and chemical, mining, textile and chemical fiber, printing and packaging, paper-making, machine

tool, plastic, hoisting, solar agricultural irrigation and other industries.

With "Market-oriented, Customer-centric" business philosophy, MICNO provides high cost performance products and service to customers, make the customers more competitive. The sales and service network is nationwide in domestic market. And our products have also been exported to more than 60 countries all over the world.

MICNO adheres to the enterprise core value of "Quality, Innovation, Integrity, Win-Win", dedicated to be the world famous supplier of products and services in the electric drive, industrial automation control fields, and would like to achieve customer, staff and enterprise values growing together.



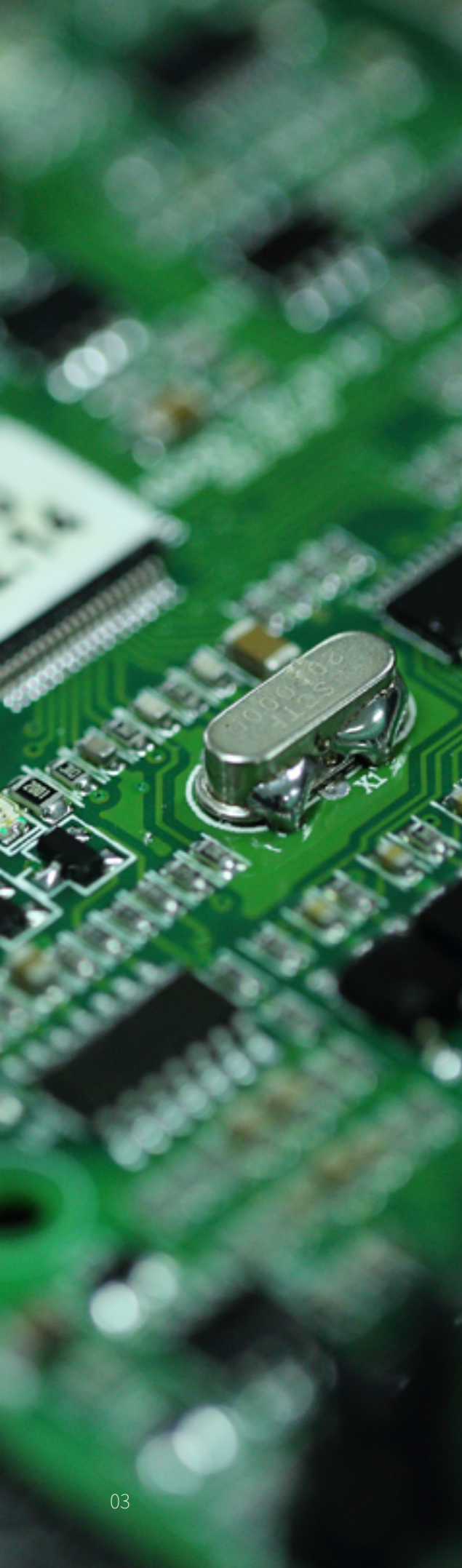

KE300A-04 single phase output inverter

KE300A-01 single phase output inverter is a kind of inverter special for single phase motor. It is based on the advanced control platform of KE300A, combining the unique start and control requirements of the single phase motor, and using a brand-new flux vector control technology to achieve true two phase orthogonal 90° flux vector control. With high start torque and high efficiency of overall unit, it can be widely applicable to single phase asynchronous motors, such as fans, pumps, power tools, etc.

Product feature

- 01 Orthogonal 90° flux vector control technology**
Use brand-new flux vector control technology to achieve true two phase orthogonal 90° flux vector control, with high start torque and high efficiency of overall unit.
- 02 High starting torque and fast dynamic response**
The new control algorithm brings better low-speed stability and stronger low-frequency loading capacity. Dynamic response time <20ms, and output 150% start torque when running at 0.5Hz.
- 03 Strong overload capacity**
150% rated current/1 minute, 200% rated current/3 seconds.
- 04 Non-stop when instantaneous power off**
With the capability of non-stop when instantaneous power off, ensuring the system continuously operate without tripping in case of instantaneous power off.
- 05 Solid EMC design and lightning protection design**
Solid EMC and lightning protection design make system run more stably.
- 06 Fast current limiting function**
With fast current limiting function, easily responding to the conditions with sudden load, greatly reducing the probability of inverter's frequent over-current fault.
- 07 Perfect protection function**
Overvoltage/ undervoltage protection, overheating protection, ground protection, short-circuit protection, overcurrent protection, overload protection and so on, all of the functions ensure the system more secure and reliable.
- 08 Easy installation and commissioning**
Special design for single phase asynchronous motor, no need to remove the start capacitor and running capacitor of motor, easy to install and commissioning.

Technical specifications

Item	Technical Index	Specification	
Input	Input voltage	1AC 220V±15%	
	Input frequency	47~63Hz	
Output	Output voltage	0~rated input voltage	
	Output frequency	V/f control: 0~3000Hz	
Control Features	Control mode	V/f control	
	Operation command mode	Keypad control	
		Terminal control	
		Serial communication control	
	Frequency setting mode	Digital setting, analog setting, pulse frequency setting, serial communication setting, multi-step speed setting & simple PLC, PID setting, etc. These frequency settings can be combined & switched in various modes.	
	Overload capacity	150% 60s, 180% 10s, 200% 3s	
	Starting torque	1Hz/150% (V/f)	
	Speed adjustment range	1:50(V/f)	
	Carrier frequency	1.0~16.0kHz, automatically adjusted according to temperature and load characteristics	
	Frequency accuracy	Digital setting: 0.01Hz Analog setting: maximum frequency * 0.05%	
	Torque boost	Automatically torque boost; manually torque boost: 0.1%~30.0%	
	V/f curve	Three types: linear, multiple point and square type (1.2 power, 1.4 power, 1.6 power, 1.8 power, square)	
	Acceleration/deceleration mode	Straight line/S curve; four kinds of acceleration/deceleration time, range: 0.1s~3600.0s	
	DC braking	DC braking when starting and stopping DC braking frequency: 0.0Hz~maximum frequency, braking time: 0.0s~100.0s	
	Jog operation	Jog operation frequency: 0.0Hz~maximum frequency Jog acceleration/deceleration time: 0.1s~3600.0s	
Simple PLC & multi-step speed operation	It can realize a maximum of 16 segments speed running via the built-in PLC or control terminal.		
Built-in PID	Built-in PID control to easily realize the close loop control of the process parameters (such as pressure, temperature, flow, etc.)		
Automatic voltage regulation	Keep output voltage constant automatically when input voltage fluctuating		

Item	Technical Index	Specification
Control Function	Common DC bus	Common DC bus for several inverters, energy balanced automatically
	Torque control	Torque control without PG
	Torque limit	"Router" characteristics, limit the torque automatically and prevent frequent over-current tripping during the running process
	Timing/length/counting control	Timing/length/counting control function
	Over-voltage & over-current stall control	Limit current & voltage automatically during the running process, prevent frequent over-current & over-voltage tripping
	Fault protection function	Up to 30 fault protections including over-current, over-voltage, under-voltage, overheating, default phase, overload, shortcut, etc., can record the detailed running status during failure & has fault automatic reset function
Input/output terminals	Input terminals	Programmable DI: 5 on-off inputs, 1 high-speed pulse input 1 programmable AI: 0~10V or 0/4~20mA
	Output terminals	1 programmable open collector output: 1 analog output (open collector output or high-speed pulse output) 1 relay output
		1 analog output: 0/4~20mA or 0~10V
	Communication terminals	Offer RS485 communication interface, support MODBUS-RTU communication protocol
Human machine interface	LED display	Display frequency setting, output frequency, output voltage, output current, etc.
	Multifunction key	QUICK/JOG key, can be used as multifunction key
Environ-ment	Ambient temperature	-10°C ~40°C , derated 4% when the temperature rise by every 1°C (40°C ~50°C).
	Humidity	90%RH or less (non-condensing)
	Altitude	≤1000M: output rated power, >1000M: output derated
	Storage temperature	-20°C ~60°C

Wiring diagram

MICNO KE300A-04 single phase output inverter has two methods of motor wiring.

01 Remove capacitor

Remove the capacitor of single phase motor, then connect the common terminal of two windings (single motor has two windings) to the V phase of inverter, and then connect the other terminal of two windings to the U & W phase of inverter separately.

Power on the inverter and set P9-13=0, start the inverter and observe the current. If the current is too large, please stop and set P0-15=10, P1-02=160. If the current still too large, please stop and switch the connection of U & W phase.

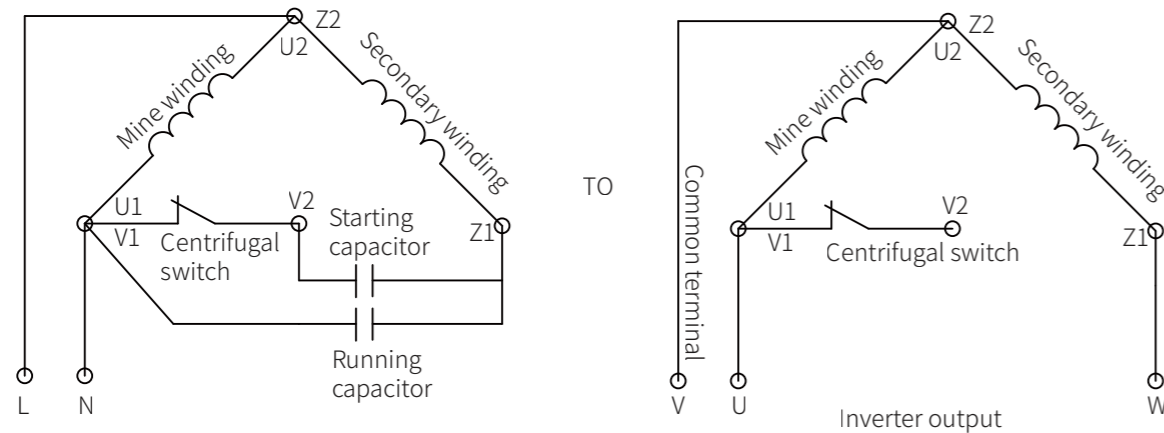

02 No remove capacitor

The motor input lines (L, N) are connected to the inverter V, U or W. Usually the default is V must be connected, U or W is optional.

Power on the inverter and set P9-13=0, start the inverter and observe the current. If the current is too large, please stop and set P0-15=10, P1-02=160. If the current still too large, please stop and switch the connection of U & W phase.

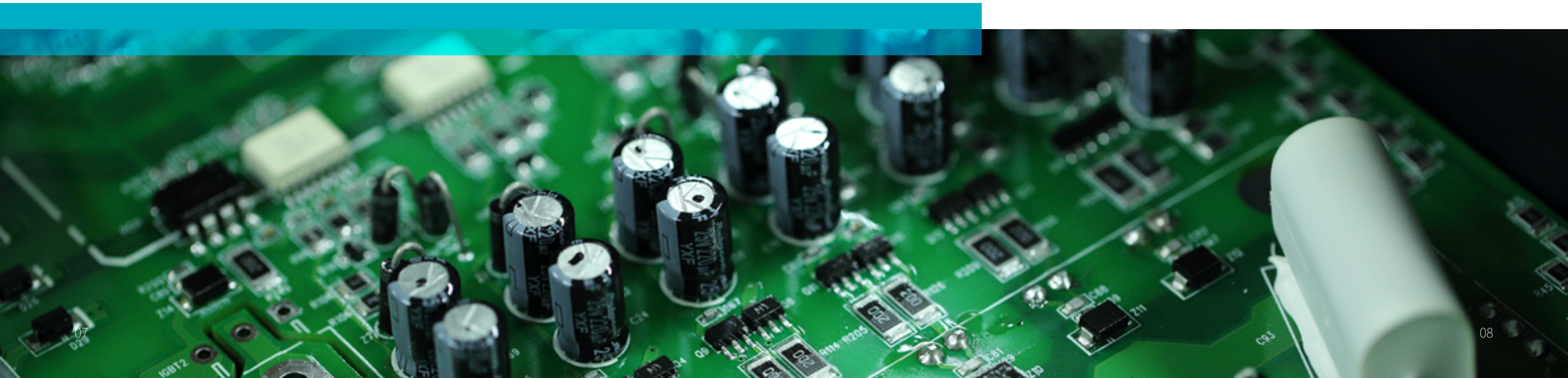
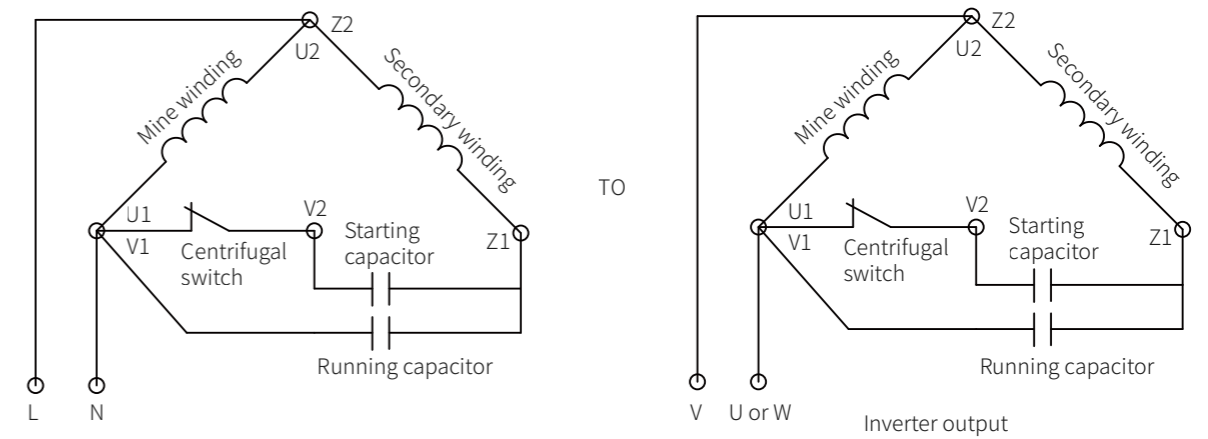

Selection guide

Model	Motor		Rated Input Current (A)	Rated Output Current (A)
	kW	HP		
KE300A-04-0R4G-S2	0.4	0.5	5.4	4
KE300A-04-0R7G-S2	0.75	1	8.2	7
KE300A-04-1R5G-S2	1.5	2	14	9.6
KE300A-04-2R2G-S2	2.2	3	23	17
KE300A-04-004G-S2	4	5	25	23
KE300A-04-5R5G-S2	5.5	7.5	38	32

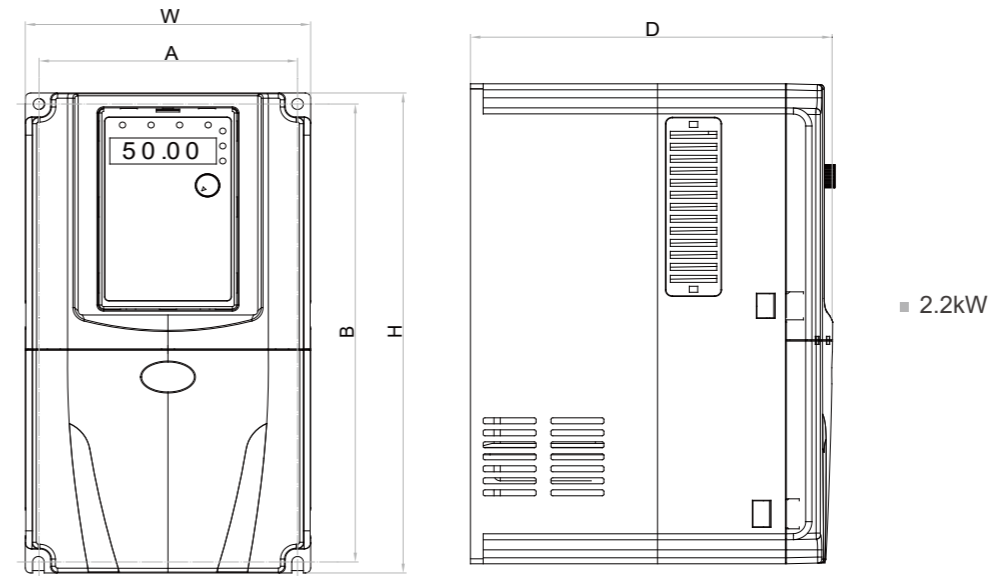

Dimension

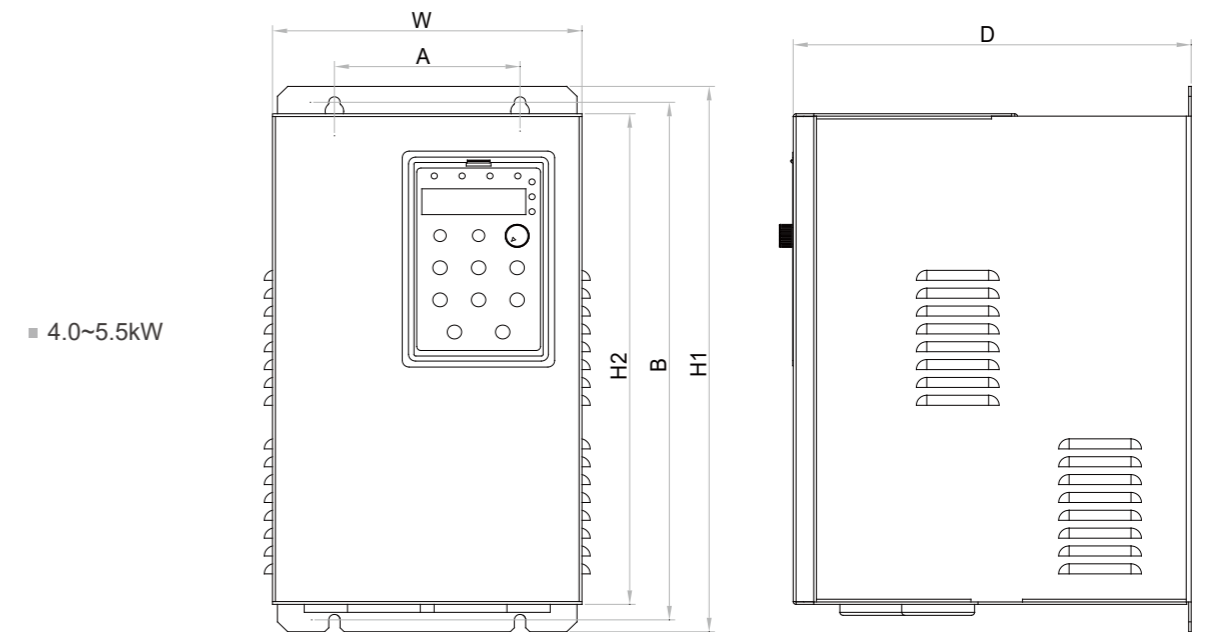
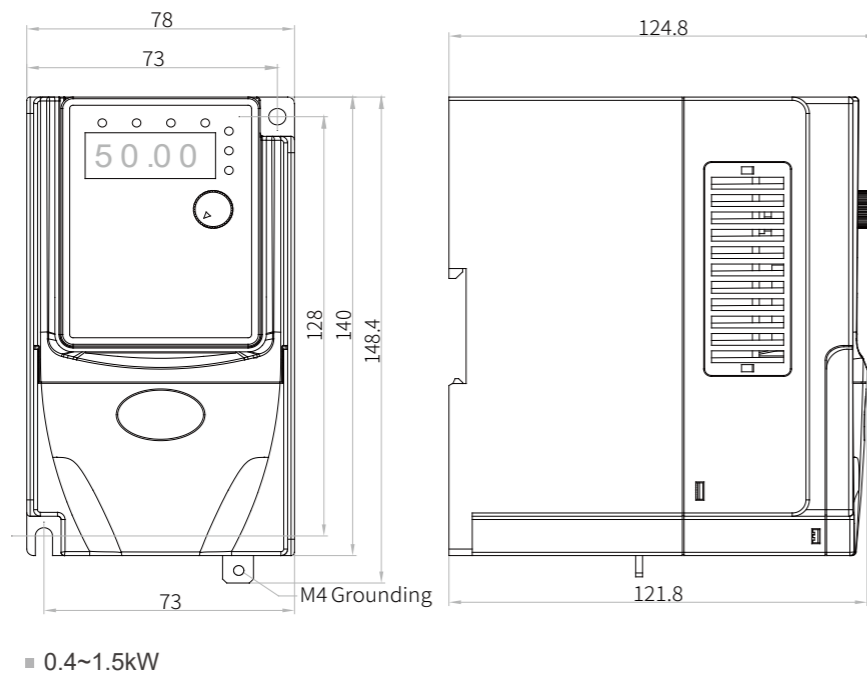

Power Rating	External Dimension (mm)				Installation Dimension (mm)		Mounting Bolt Model (mm)
	W	H1	H2	D	A	B	
KE300A-04-0R4G-S2	78	148.4	124.8	73	128	M4	
KE300A-04-0R7G-S2							
KE300A-04-1R5G-S2							
KE300A-04-2R2G-S2	135	240	173	122.6	229	M4	
KE300A-04-004G-S2	170	314	285	167	90	301.6	M4
KE300A-04-5R5G-S2	200	329.1	300	177.2	90	316.6	M4